

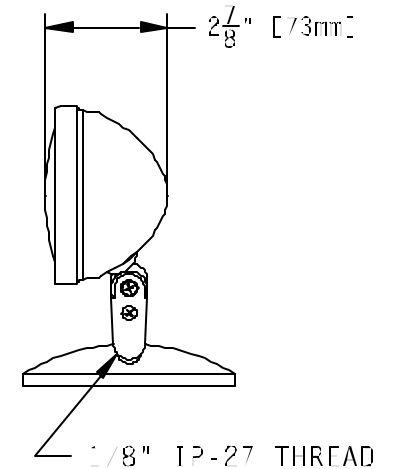

4502 Series Par 36 Metallic Lamphead

5 Wisconsin Ave.
Norwich, CT 06360
Tel. (860) 887-4550
Fax (860) 887-4534
www.lamphead.com (Product)
www.nutron-mfg.com (Company)

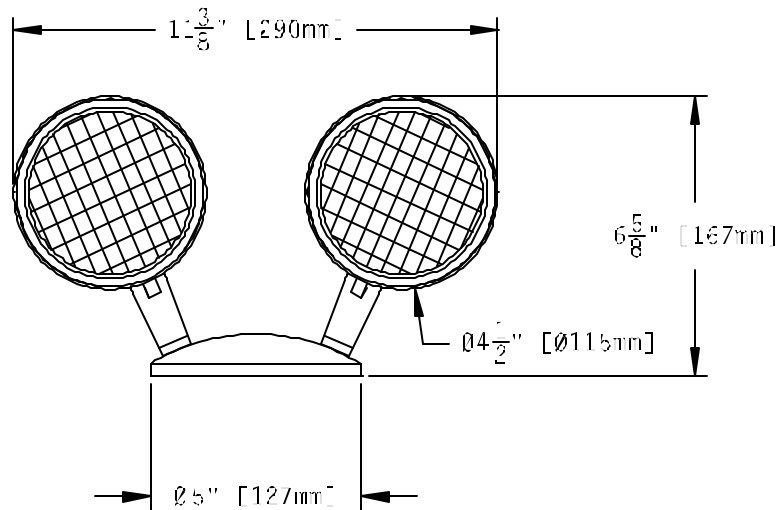

Housing - Aluminum w/ Die Cast Swivel

Colors/Finish - Clear Anodize, Chrome, Powder coated White & Black (Custom Colors are available, consult factory for details)

Lamping:

- Par 36 Sealed Beam
- 6, 12v Wedge Base
- 6, 12v Bi Pin Halogen
- Double Contact Bayonet Base

Metallic Canopy available in various configurations